

# PRODUCT DATA

VP 18 M2 BY NILAN



Horsham, West Sussex  
01403 563045



Domestic



Active  
heat recovery



Ventilation  
<300 m<sup>3</sup>/h



Comfort  
heating



Comfort  
cooling



Sanitary  
hot water  
production



Heating

# ACTIVE HEAT RECOVERY

VP 18M2 ventilates the home via an active heat recovery function that recovers the energy in the hot air that is extracted from the home, transferring it to the supply air.

The center of a ventilation system with active heat recovery is a heat pump that, in general terms, comprises of an evaporator and a condenser. The energy in the hot air extracted from the home is taken up by the evaporator before the air is led outdoors. The condenser then transfers the energy from the evaporator to the cold air intake before it is streamed into the home, thereby eliminating the heat loss.

Compared to a counterflow heat exchanger, which recovers up to 90% of the heat, the heat pump utilizes 100% of the heat, both to heat the supply air and to produce hot water.

In the summer, the process is reversed from heating to cooling, so that the system cools the fresh summer air flowing into the home. The VP 18M2 system can cool the air in relation to the outdoor temperature. Due to the low air exchange, VP 18M2 cannot be compared with air conditioning. Besides cooling the air intake, humidity is reduced, ensuring a good comfort level, even with a high indoor temperature.

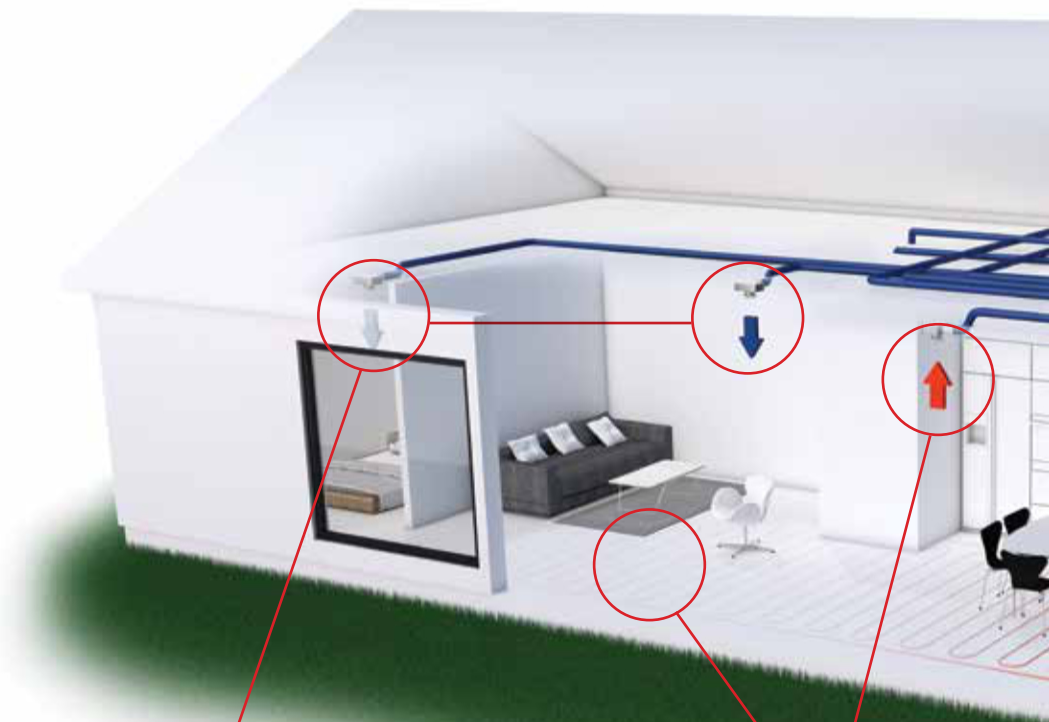

## Supply air

Fresh, filtered, temperate air is blown into every room of the home, ensuring a healthy and pleasant indoor climate, 24 hours a day.

## Central heating system (only VP 18 M2 EK)

The heat from VP 18 M2 EK is used for space heating via a waterborne central heating system (radiators or floor heating system).

## Extract air

The used, moist air is extracted from the home via ceiling valves in all wet rooms, as well as the kitchen.

**Discharge air**

When the VP 18 M2 system has recovered the heat from the outlet air, the used, moist air is extracted from the home.

**Fresh air**

Via an air valve in the home's facade or roof, fresh air is drawn in from the outdoors and channelled to the VP 18 M2 system.

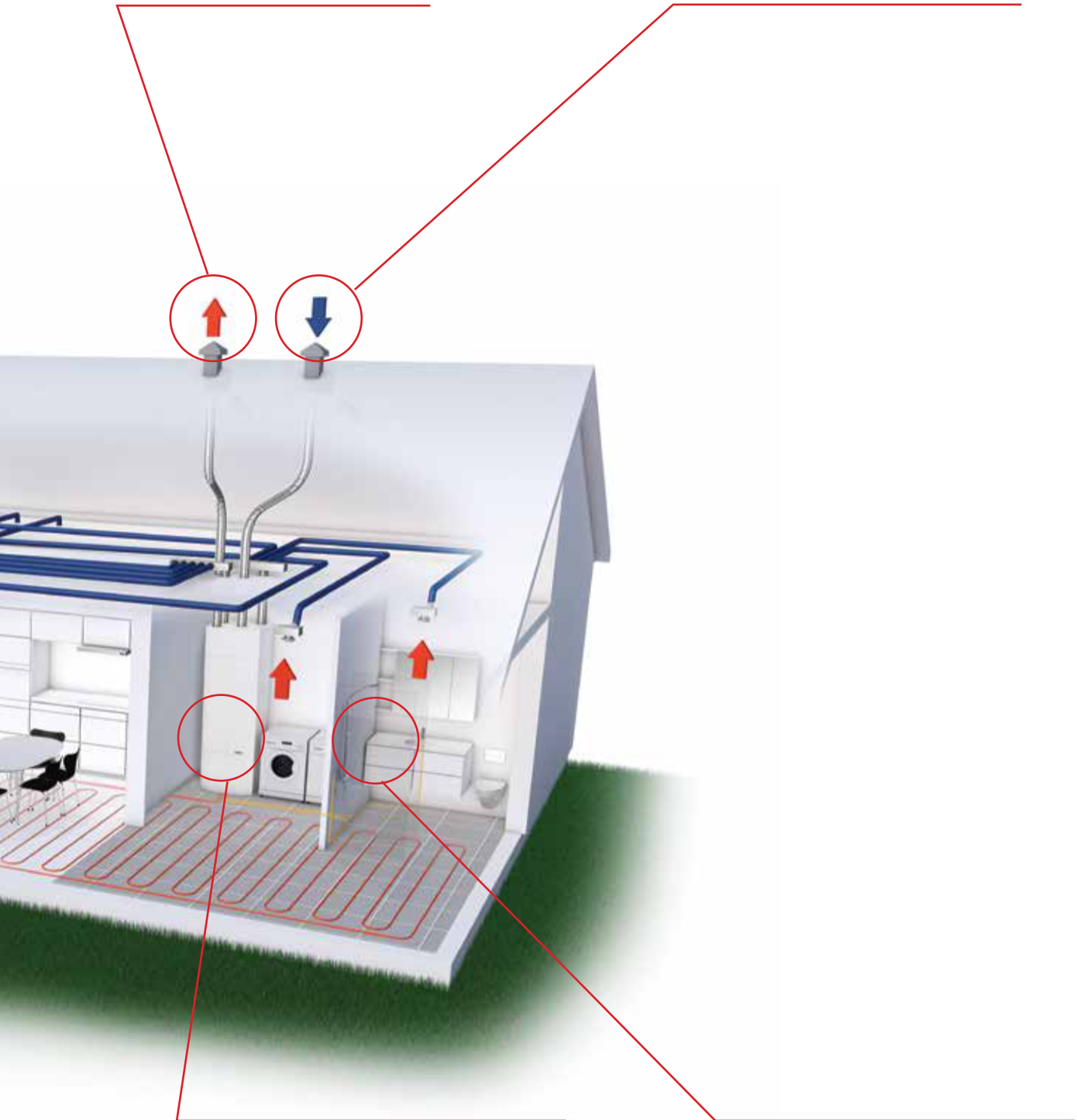

**VP 18 M2**

The unit regulates air flows, heat recovery, production of hot water and any heating of the home that is required. It can be located in a utility or technical room.

**Sanitary hot water**

VP 18 M2 recovers the heat from the extracted air and uses it to produce hot water.

# VP 18 M2



## Product description

The VP 18 M2 unit is designed for installation in utility or technical rooms and is suitable for homes with an air exchange requirement of up to 300 m<sup>3</sup>/h.

The unit combines ventilation with active heat recovery, production of hot water and comfort heating, in one compact, space-saving solution.

VP 18 M2 is the obvious choice for homes with limited space, as it does not require more space than an ordinary wall cabinet. This should be compared to solutions with separate ventilation, heating and hot water installations, which can soon fill up a utility or technical room.

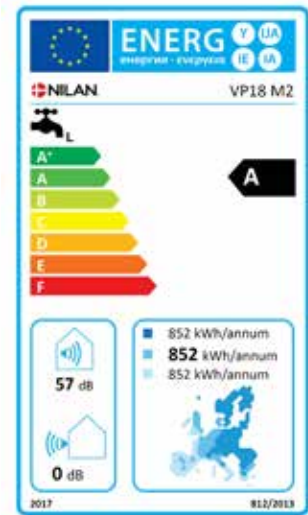

## Dimensional drawing

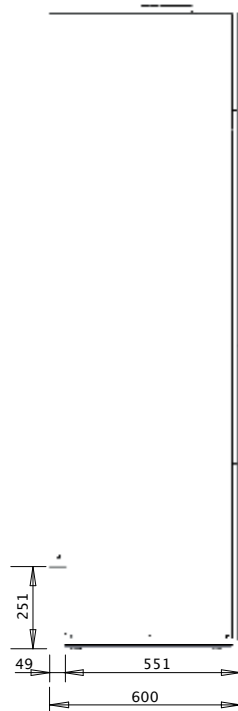
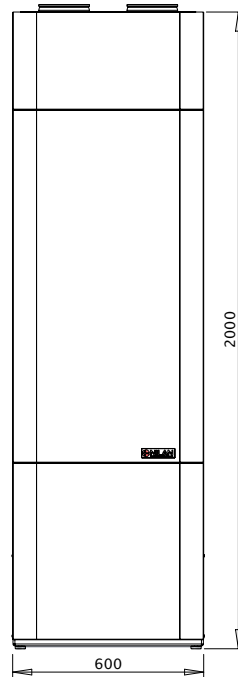
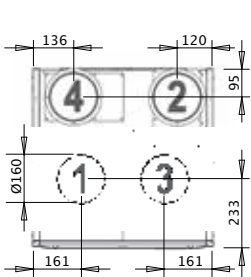

VP 18 M2

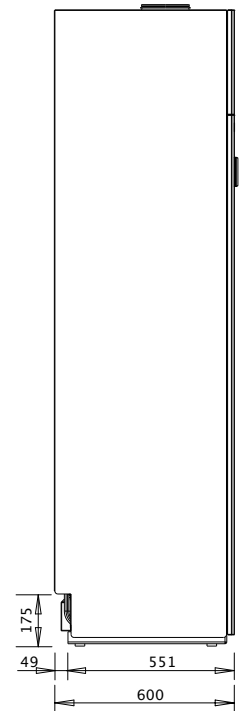
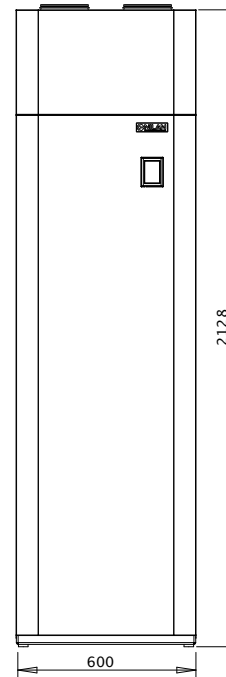

VP 18 M2 EK

### Connections

- 1: Fresh air
- 2: Supply air
- 3: Extract air
- 4: Discharge air

Time-controlled filter change alarm.  
Easy filter access by opening the top front panel with the help of two finger screws.

There is plenty of space to replace filters and to vacuum clean the filter space.

Heating pump with hermetically sealed cooling circuit, for production of hot water and active heat recovery.

Hermetically-sealed cooling circuit.

The efficient fans are powered by energy-saving EC motors.

They provide a constant air volume with a four-step adjustment.

Reversible cooling circuit that can also cool the air intake in the summer up to 10 °C, with simultaneous hot water production.

Electrically monitored sacrificial anode and corrosion protection.

180 l hot water tank.  
2 layers of glass enamelling to ensure a long lifetime.

Attractive white-painted front with large front panels, giving easy access to service the system.

Intelligent humidity control.  
Adapts ventilation to the home's current humidity level.

CO<sub>2</sub>-sensor can be purchased, for further demand management.

The unit comes with a clear and user-friendly HMI Touch panel.



The modern CTS 602 control runs Modbus communication.

The cooling circuit is driven by a reliable piston compressor.

A powder-coated condensation tray prevents the formation of "acidwater", leading out the condensation water.

VP 18 M2 has an integrated water lock.

1.5 kW electrical completion.  
For high hot water consumption where the heating pump cannot cope.

Emergency operation.

The hot water tank is foam-insulated, giving good insulation and saving energy.

Automatic anti-legionella.

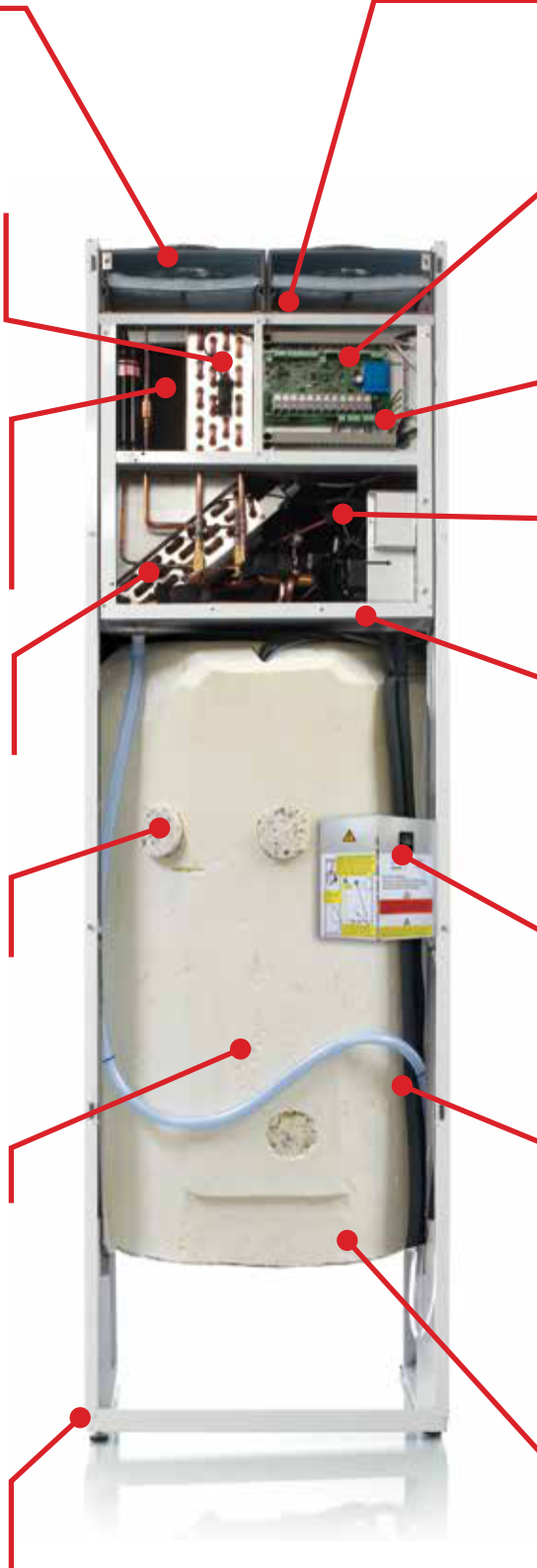

# PLANNING DATA

## Technical specifications

Dimensions(W xD xH) VP 18 M2	600 x600 x2000 mm
Dimensions(W xD xH) VP 18 M2 EK	600 x600 x2128 mm
Weight	150 kg
Plate type casing	Aluzinc steel plate, white powder coatingRAL9016
Compressor type	Piston compressor
Refrigerant	R134a,1000 g
Fan type	EC,constant rotation
Filter class	ISOCoarse >90%(G4)
Duct connections	Ø160 mm
Condensate drain	PVC, Ø20x1,5mm
CapacitySHW tank	180 L
Supplementary electrical heating (sanitary hot water)	1,5 kW
Sanitary connection dimension	3/4"

External leakage (*1)	<1,4%
Internal leakage (*2)	<1,1%
Supply voltage	230 V (±10%),50/60 HZ
Max.input/power	2,2 kW/ 9,5 A
Tightness class	IP31
Standby power	3 W
Ambient temperature	-20/+40 °C

\*1 At ±250 Pa and m<sup>3</sup>/h according to EN 308/EN 13141-7.

\*2 At ±100 Pa and m<sup>3</sup>/h according to EN 308/EN 13141-7.

## Hot water production

Consumer profile,water heater	L (large)
Energy efficiency class	A
Energy efficiency for water heating- average climate	118 %
Annual electricity consumption -average climate	852 kWh/annum
Temperature settings on the thermostat	10 -65 °C
Sound power level L <sub>WA</sub>	57 dB(A)
The water heater can function outside peak load periods (Smart-grid)	No
Guidelines for assembly, installation and maintenance	See installation instructions
Energy efficiency for water heating-cold climate	118 %
Energy efficiency for water heating-warm climate	118 %
Annual electricity production -cold climate	852 kWh/annum
Annual electricity consumption -warm climate	852 kWh/annum

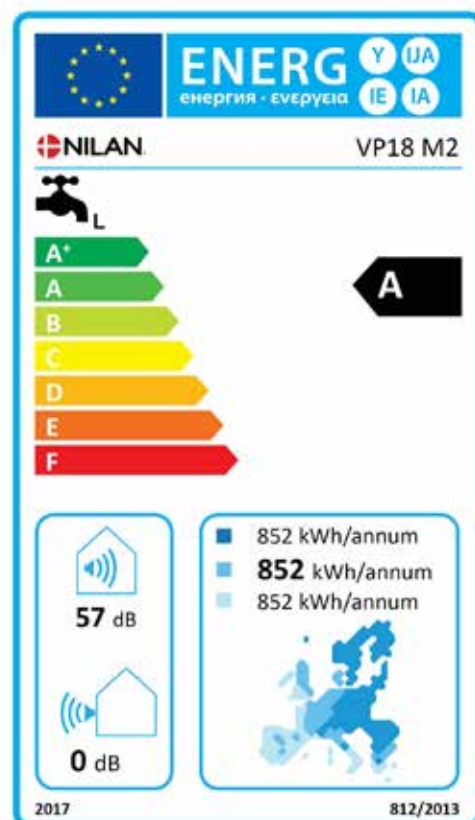

## Capacity

Capacity of standard unit as a function of  $q_v$  and  $P_{t,ext}$ .

SEL values according to EN 13141-7 are for standard units with ISO Coarse >90% (G4) filters and without heating element.

SEL values comprise the unit's total power consumption incl. control.

Conversion factor:  $\frac{J/m^3}{3600} = W/m^3/h$

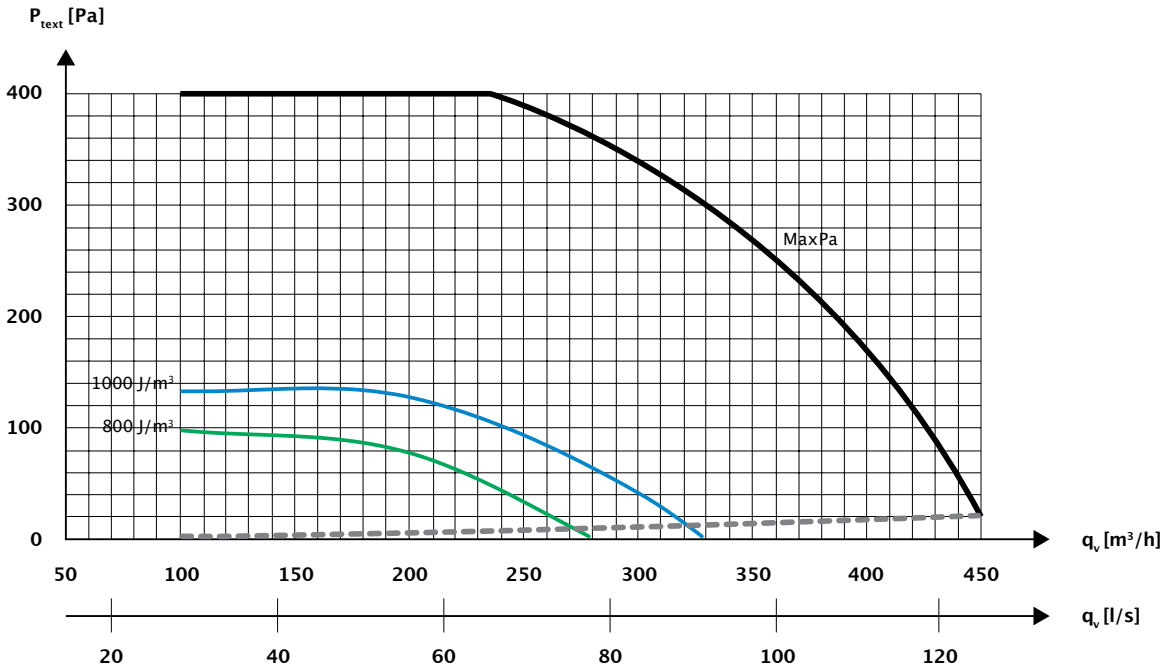

## Heat output supply air

Heat output  $Q_c$  [W] as a function of  $q_v$  [ $m^3/h$ ] and outdoor air temperature  $t_{z1}$  [ $^{\circ}C$ ]. In accordance with EN 14511,  $t_{z1} = 21^{\circ}C$  (extract air)

Heat output is the contribution to room heating added to the fresh air via VP 18 to the supply air.

The ventilation loss is the heat output that is lost without heat recovery at the given volume flow air.

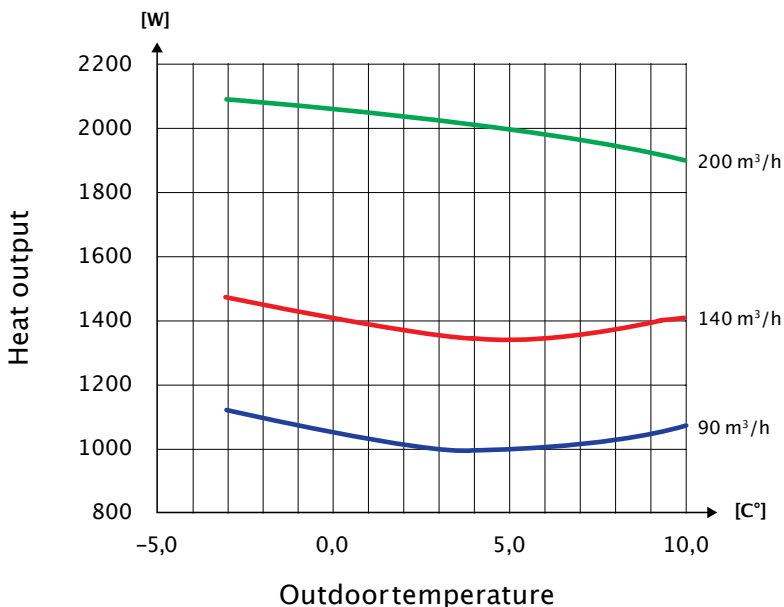

# PLANNING DATA

## COP (air-air)

Heat output factor COP [-] supply air as a function of outdoor temperature  $t_{21}$  [°C] and volume flow  $q_v$  [m<sup>3</sup>/h] in accordance with EN14511 at a room temperature  $t_{11} = 21^\circ\text{C}$

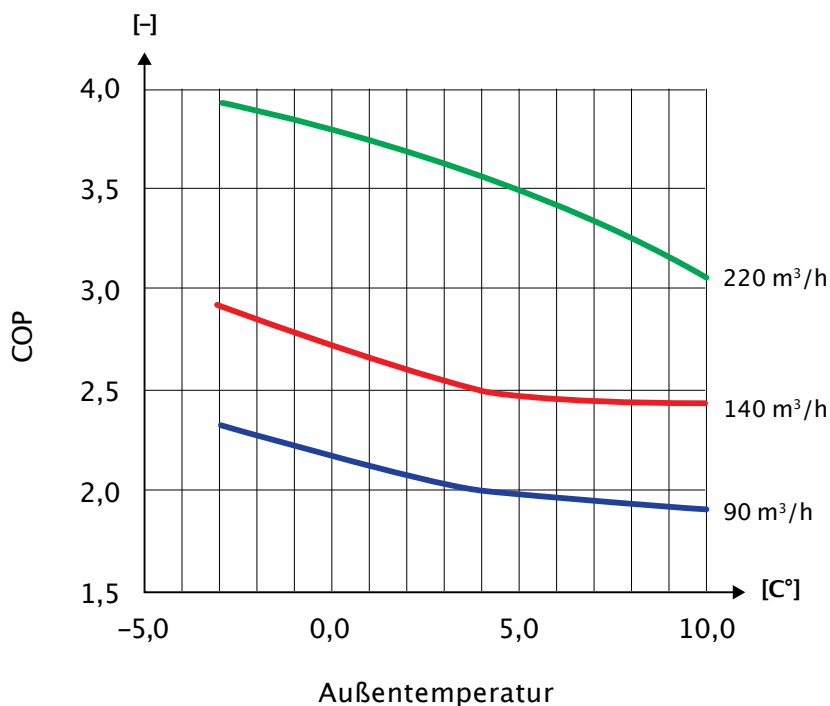

## Tappedwater

Tapped volume in litres  $V_{\max}$  [L] from VP 18 tank as a function of tapped temperature  $t$  [°C] and tank temperature at 40°, 50° and 60°C

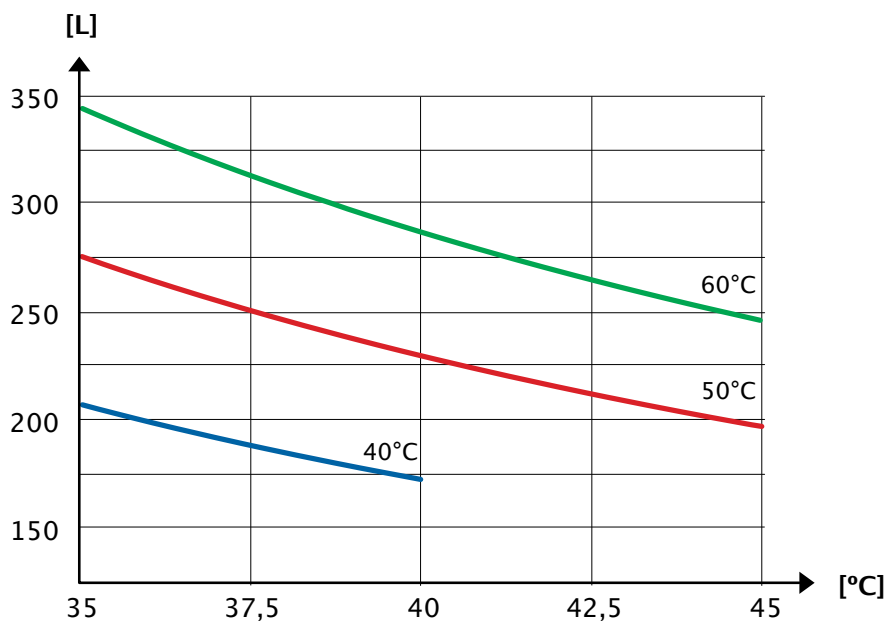



## Sound data

Sounddata is for  $q_v = 210 \text{ m}^3/\text{h}$  and  $P_t, \text{ ext} = 100 \text{ Pa}$  in accordance with EN 9614-2 for surface and EN 5136 for ducts.

Sound output level LWA drops with falling air volumes and falling back-pressure.

At a given distance, the sound pressure level  $L_pA$  will depend on the acoustic conditions at the installation site.

### Sound output level ( $L_{wa}$ )

Octave band Hz	Surface dB(A)	Supply air dB(A)	Extract air dB(A)
63	-	51	38
125	-	59	46
250	-	66	51
500	-	61	41
1.000	-	56	31
2.000	-	54	28
4.000	-	47	20
8.000	-	40	13
Total $\pm 2$	57	69	53

# AUTOMATION

## CTS 602 Control



VP18 M2 is controlled using its CTS 602 HMI touch panel, featuring a wide range of functions, e.g., menu-controlled operation, weekly programme settings, filter monitor with timer, fan speed adjustment, summer bypass, supply-heating element control, error messages etc.

The CTS 602 comes with factory settings, including a default setting which can be customised to operational requirements to achieve optimum operation and utilisation of the system.

There is an option for selecting between 2 front page images for the main screen.

Operating instructions for the CTS 602 can be found in a separate user manual supplied with the unit.

## External communication

The CTS 602 control unit communicates by default with Modbus RTU RS485 communication. A CTS system using this form of communication can easily be connected to the unit.

Nilan units have an open Modbus communication, i.e. not only can the unit be monitored, but its operation can also be set in the same way as it can via the operating panel.

The protocol is set up by default for a Modbus RTU 30 address, but can be set to a value between 1 and 247.

A Modbus converter allows you to connect one or more units to a computer to monitor and control the unit.

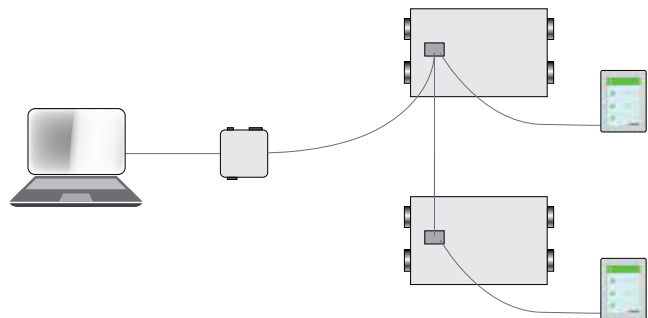

Functional overview		+Standard -Accessories
3 levels	The control function is divided into 3 levels: User/Service/Factory with various options at each level	+
Weekly plan	The unit has 3 weekly programmes (with a factory setting of "off") <ul style="list-style-type: none"> <li>• Programme 1: for working families</li> <li>• Programme 2: for stay-at-home families</li> <li>• Programme 3: for businesses</li> </ul> There is also an option for you to set your own weekly programme.	+
User option 1	This allows you to override the operating mode in the main menu via an external potential-free contact or PIR sensor.	+
User option 2	With an Expansion PCB mounted, allows you to make additional connections, e.g. <ul style="list-style-type: none"> <li>• User option 2 overrides User option 1 (e.g. connecting an EM box)</li> <li>• Up to 500 W direct</li> <li>• Output relai</li> <li>• Switching the central heating system on/off</li> </ul>	-
Alarms	Alarm log featuring the last 16 alarms.	+
Datalog	Possible to log data. Kapacity 46.000 logs <ul style="list-style-type: none"> <li>• Adjustable between 1 and 120 minutes</li> <li>• If "OFF", only events and alarms are logged</li> </ul>	+
Filter monitor	Filter monitor with timer (factory setting of 90 days). Adjustable to 30/90/180/360 days.	+
Bypass	Bypassing the outdoor air reduces heat recovery when heat recovery are not needed.	+
Air quality	Allows you to choose whether to switch humidity sensors and/or CO <sub>2</sub> sensors on and off.	+/-
Humidity control	Allows you to set a higher or lower ventilation step in the case of high/low air humidity.	+
Summer/Winter operation	Possible to set operation for summer and winter	+
Winter low	Allows you to select a low ventilation step in the case of low outside temperatures	+
Defrost function	Temperature-based automatic function for defrosting the heat exchanger.	+
Frost protection	In case of failing heating system, the unit is turned off to avoid further cooling with a risk of the water heating coil frost bursting.	+
Temperature control	Allows you to select the temperature sensor which will control the unit. <ul style="list-style-type: none"> <li>• T15 ROOM (panel sensor)</li> <li>• T10 EXT (fitted in a representative extraction valve)</li> <li>• T3 EXHAUST (extract air)</li> </ul>	+
Room low	Stops the unit at a low room temperature. Hereby is cooling of the home avoided in case of a failing central heating system. Standard set to OFF. Can be set from 1 to 20 degrees and is controlled by: <ul style="list-style-type: none"> <li>• T15 ROOM (panel sensor)</li> <li>• T10 EXT (fitted in a representative extraction valve)</li> <li>• T3 EXHAUST (extract air)</li> </ul>	+
Air volume	Allows you to set four ventilation steps. Supply air and extract air are set individually. Step 1 <25% - Step 2 <45% - Step 3 <70% - Step 4 <100%	+
Legionella control	One weekday can be chosen where the sanitary water temperature is raised to 65 °C (e.g. Monday between 1 am to 6 am).	+
External fire alarm	Possible to connect the unit to external fire alarm.	+
Joint alarm	Outlet for joint alarm	+
Constant pressure control	Allows control from both the extract air and supply air side.	-
Cooling	Via bypass or heat pump. The heat pump has a reversible circuit, which means that the unit's circuit is reversed and the unit cools, rather than heating, the supply air. It is possible to choose whether the unit is to run a higher or highest ventilation stage during cooling. Via a weekly plan night cooling can be set up.	+
Intake air control	Allows you to set the regulator to control the intake air temperature/supply air (only available if the control unit has been configured for a supply-heating element).	+
Delayed start-up	There is a possibility for a delayed start-up by the fans, when a closing damper is installed.	+
Reset	Allows you to restore the factory settings.	+
Manual test	Allows you to test the unit's functions manually.	+
Language	Option for setting the relevant language (Danish/Finnish/Norwegian/Swedish/German/English/French).	+

# ACCESSORIES



## EM-box

An EM-box allows heat recovery from the air from the range hood and thereby helps to heat the supply air. The EM-box is equipped with a special filter which efficiently cleans the range hood air of fat particles and thereby protects the system.



## Pollen filter ISO ePM1 50–65% (F7)

A pollen filter class ISO ePM1 50–65% (F7) can be fitted in the unit. The pollen filter is fitted with the plate filter ISO Coarse >90% (G4).



## Expansion PCB

The expansion PCB provides additional functions for the CTS 602 control unit, e.g., controlling the EM-box (see list of functions on page 11).

# DELIVERY AND HANDLING

## Transport and storage

VP 18 M2 comes in factory packaging that protects it during transport and storage.

VP 18 M2 must be stored in a dry place in its original packaging until installation. The packaging should only be removed immediately prior to installation.

## Installation conditions

During installation, future service and maintenance should be taken into account. We recommend a minimum gap in front of and behind the unit of 60 cm.

The unit must be installed level for the sake of the condensate drain.

## Installation of electric heating element

Electric heating elements (accessories) are fitted in the duct. The heating element must be insulated using fire-resistant insulation material. The electric heating element must be connected by an authorised electrician.

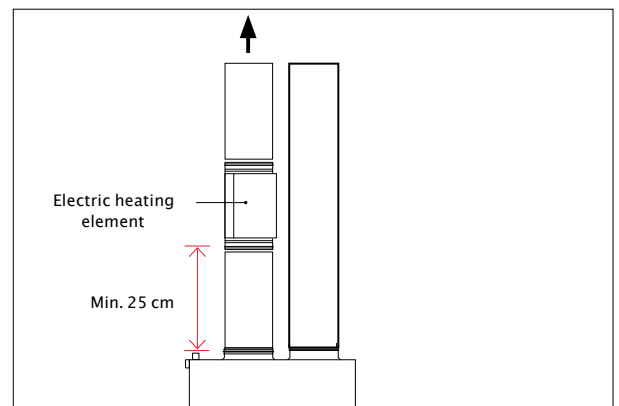

# VP 18 M2 VARIANTS

## Solutions

The flexible VP 18 M2 series features four different units that can meet any need for ventilation and hot water –from the basic to the more advanced levels.

### VP 18 M2

VP 18 M2 is the basic model, with active ventilation of up to 300 m<sup>3</sup>/h and production of hot water in a 180-l tank.

This system is described on the preceding pages.

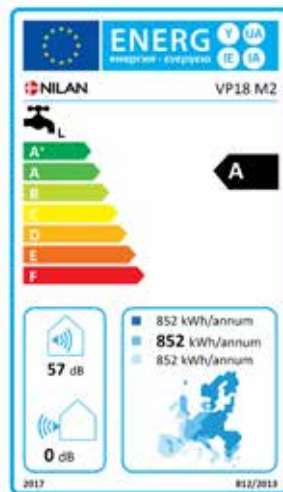

### VP 18 M2 cooling/solar

Select VP 18 M2 with cooling and solar function, for cooling of the supply air and if there is a need for extra hot water, e.g. a spa bath.

#### Cooling function

A newly built house will be well-sealed and insulated, making it is easy to keep warm, but during hot spells it may be difficult to keep the home cool. The VP 18 M2 cooling function operates via the reversible cooling circuit that can cool the outdoor air by up to 10 °C. This is not the same as air conditioning, however, but when the supply air is cooled down, the level of humidity in the home will decrease, making the indoor climate more comfortable.

#### Solar function

With the help of an extra heating element, the unit can be connected to a solar panel, oil, gas or other fuel source, to increase the production of hot water.



## VP 18 M2 EK

VP 18 M2 EK is a VP 18 unit with a built in 9-kW electrical boiler that is connected to a waterborne central heating system, for electrical heating of the home.

One of the big advantages of the VP 18 M2 EK is that it does not require pipes buried in the ground, or the installation of an air extraction heat pump, as in the case of traditional heat-pump based heating solutions.

Heat output	9 kW
Supply voltage	3 x230V / 3 x400V
Fuse size (3 x230 V)	16A
Fuse size (3 x400 V)	16A
Weight	21 kg
Standby power	2W
Pressure expansion vessel	10 l
Control	CTS 602

## VP 18 M2 EK Cooling/solar

With VP 18 M2 EK cooling/solar, all solutions are gathered in one unit.

Ventilation, hot water and central heating are combined in one unit that does not take up more space than an ordinary wall cabinet. This should be compared to solutions with separate ventilation, heating and hot water installations, which can soon fill up a utility or technical room.

Model	EK 9 kW
Condensing boiler	No
Low temperature boiler	No
B1 boiler	No
Cogeneration space heater	No
Combination heater	No

Item	Symbol	Value	Unit
Rated heat output	$P_{rated}$	8,914	kW
At rated heat output and high-temperature regime	$P_4$	8,914	kW

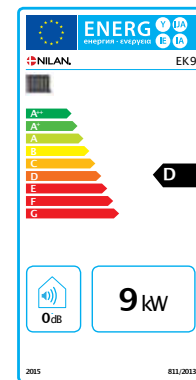

Item	Symbol	Value	Unit
Seasonal space heating energy efficiency	$\eta_s$	40	%
At rated heat output and high-temperature regime	$\eta_4$	40	%
Other items			
Standby heat loss	$P_{stby}$	0,0864	kW

# INFORMATION FROM A TO Z

Nilan develops and manufactures premium-quality, energy-saving ventilation and heat pump solutions that provide a healthy indoor climate and low-level energy consumption with the greatest consideration for the environment. In order to facilitate each step in the construction process - from choosing the solution through to planning, installation and maintenance - we have created a series of information material which is available for download at [www.nilan.dk](http://www.nilan.dk).



## Brochure

General information about the solution and its benefits.



## Product data

Technical information to ensure correct choice of solution.



## Installation instructions

Detailed guide for installation and initial adjustment of the solution.



## User manual

Detailed guide for regulation of the solution to ensure optimum day-to-day operation.

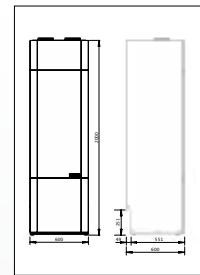

## Drawings

Tender documents and 3D drawings are available to download for planning purposes.



Horsham, West Sussex  
01403 563045

[www.slsgroup.com](http://www.slsgroup.com)